

Throttle Valves

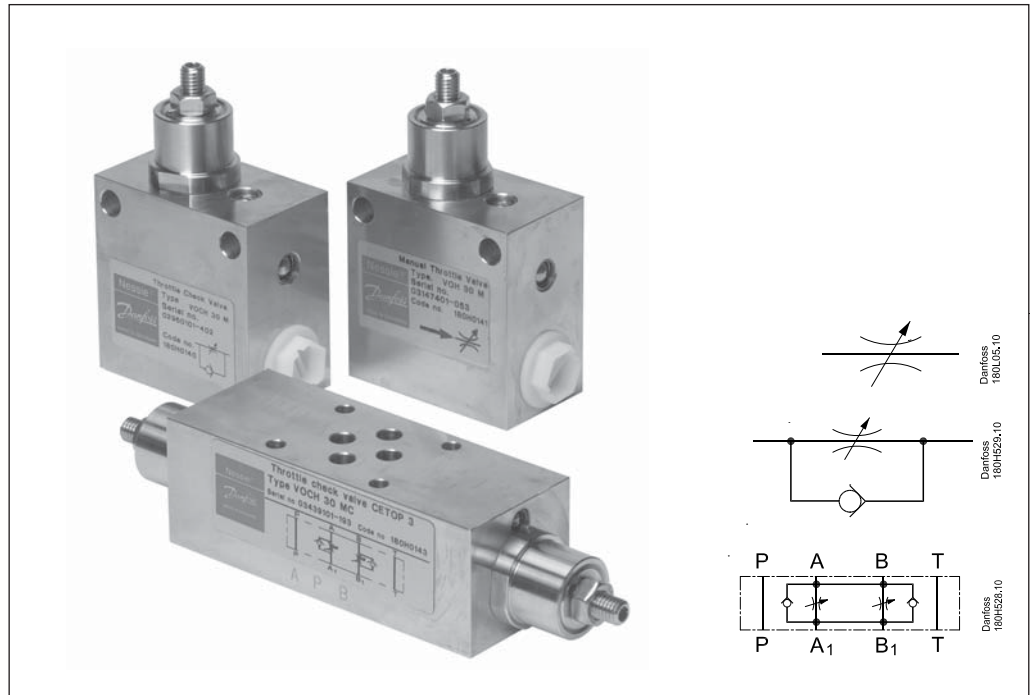

Manually Variable Throttle Valve

- VOH 30 M (inline mounted)

VOH 30 M regulates the flow in both directions.

Manually Variable Throttle Check Valve

- VOCH 30 M (inline mounted)
- VOCH 30 MC (cetop 3 block mounted)

VOCH 30 M and VOCH 30 MC regulate the flow in one direction and allow for free passage in the opposite direction via an integrated check valve.

Application

The valves regulate flow and thus e.g. the speed of an actuator (motor or cylinder). The valves are designed for ordinary tap water without additives of any kind, but are also suit-

able for applications operating on air, neutral gases and oil compatible with the NBR O-ring material used.

Function

The valves are designed to operate according to the needle controlled valve principle.

VOCH 30 MC is a double throttle check valve working as an intermediate block to a cetop 3 standard, consisting of a block, VOCH 30 MC and directional valve, type VDH 30EC4/3.

Advantages

- Accurate flow regulation
- Flow rates easy to set
- Corrosion resistant surfaces, mainly stainless steel
- Adjustment position secured with lock nut

Variants

The valve housing comes as standard in stainless steel AISI 304 (W.nr. 1.4301). On request the valve housing for VOCH 30 MC is available in stainless

steel AISI 316L (W.nr. 1.4401). Please contact the Danfoss sales organization for water hydraulics.

Filtration

The water supplied to the valve must be filtered: 50 µm absolute filter is recommended.

For further information on filters, please contact Danfoss sales organization for water hydraulics.

Temperature

Storage temperature:
 • -40°C to +70°C – provided that the valve is drained of fluid and stored “plugged”

Operation on water containing antifreeze:
 • Fluid temperature and ambient temperature: -30°C 1) to +50°C

Operation on (clean) water:
 • Fluid temperature and ambient temperature: +2°C to +80°C

1) please see paragraph on antifreeze protection

Antifreeze Protection

If a system requires antifreeze protection, Danfoss recommends Dowcall N or Chillsafe mono propylene glycol from the Dow Chemical Company and Arco Chemical Company, respectively. Both antifreezes are biologically degradable and must be used together with demineralized water. Mixing ratio must be:

- min. 30% antifreeze and 70% demineralized water providing frost protection to -13°C.
- max. 50% antifreeze and 50% demineralized water due to increased viscosity, providing frost protection to -30°C.

Technical Data

	VOH 30 M	VOCH 30 M	VOH 30 MC	VOCH 30 MC
Max pressure cont.	140 bar	140 bar	140 bar	140 bar
Max pressure drop across the valve	140 bar	140 bar	140 bar	140 bar
Max. flow	30 l/min	30 l/min	30 l/min	30 l/min
Pressure loss at 30 l/min	15 bar	15 bar	23 bar	23 bar
Pressure loss at 15 l/min	4 bar	4 bar	8 bar	8 bar
Min. adjustable flow at 140 bar	3 l/min	3 l/min	3 l/min.	3 l/min.
Max. leakage for closed valve at 140 bar	50 ml/min.	50 ml/min.	50 ml/min.	50 ml/min.
Pressure loss across check valve at 30 l/min	-	4.5 bar	-	5 bar
Adjustment screw (from min. to max. flow)	7 ½ omdr.	7 ½ omdr.	7 ½ omdr.	7 ½ omdr.
Port connection	G ¾"	G ¾"	Cetop 3	Cetop 3
Steel type	AISI 304	AISI 304	AISI 304	AISI 304
O-ring material	NBR	NBR	NBR	NBR
Weight	1,30 kg	1,30 kg	1,90 kg	1,90 kg

Code numbers

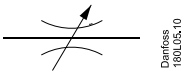
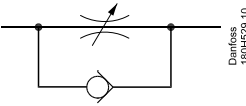
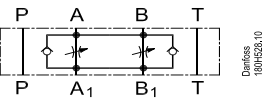
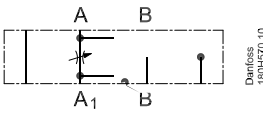
Valves	Function symbol	Code number
VOH 30 M	 Danfoss 180H05.10	180H0141
VOCH 30 M	 Danfoss 180H029.10	180H0140
VOCH 30 MC	 Danfoss 180H028.10	180H0143
VOH 30 MC	 Danfoss 180H070.10	180H0147

Flowrate curves
(for water)

VOH 30 M
Pressure losses at various opening degrees

Primary flow direction

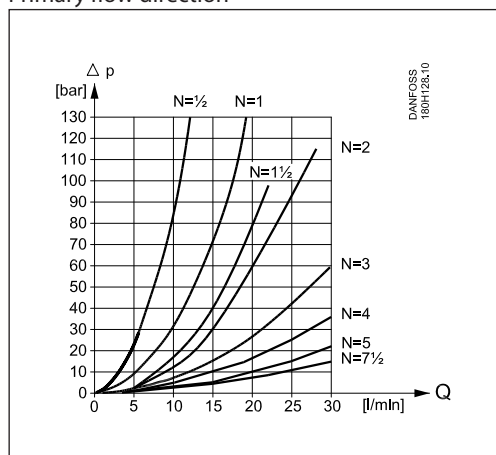

Secondary flow direction

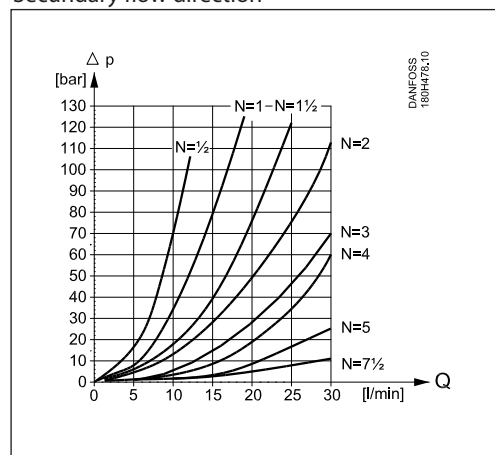

VOCH 30 M
Pressure losses at various opening degrees

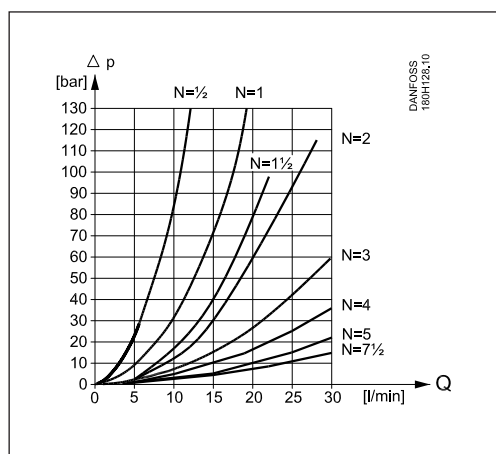

VOCH 30 M and VOCH 30 MC
Pressures drop across the check valve as a function of the flow

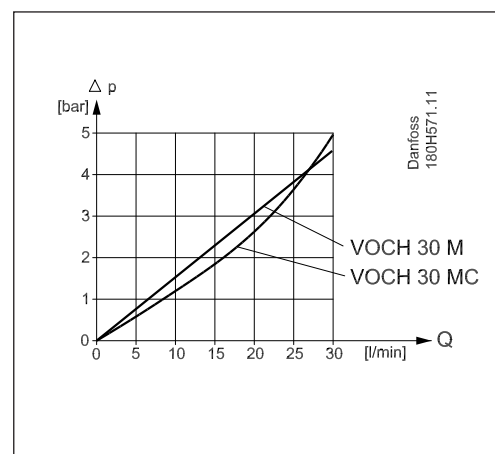

VOCH 30 MC and VOH 30 MC
Pressure losses at various opening degrees

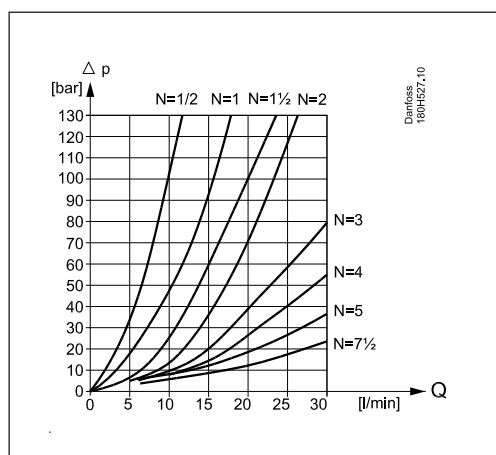

VOH 30 MC
Pressures drop across the check valve as a function of the flow

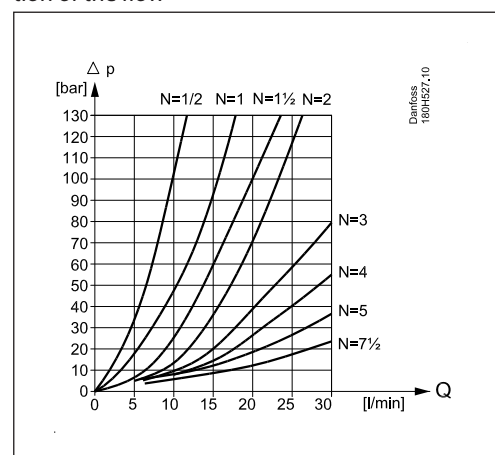

N is the number of rotations of the adjusting screw.
At N = 0 the valve is fully closed (lower position).

Mounting of inline valves

Inline valves are mounted in line in flow direction (follow the arrow on the valve) and fixed either

directly in the pipe connections or with bolts in the fixation holes on the valve.

Mounting of valve on Cetop block

The valve is designed to be mounted on a block with cetop 3-port connection. Four stainless steel screws and four O-rings are supplied with the valve for mounting. Remember to smear/spray

the threads on the screws with Molykote® D pasta from Dow Corning, or Klüber UH1 84-201 from Klüber lubrication, before mounting the valve.

Inline valves

**Dimensions (mm)
VOH 30 M and VOCH 30 M**

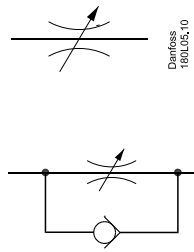

Danfoss
180M523.10

Danfoss
180M523.10

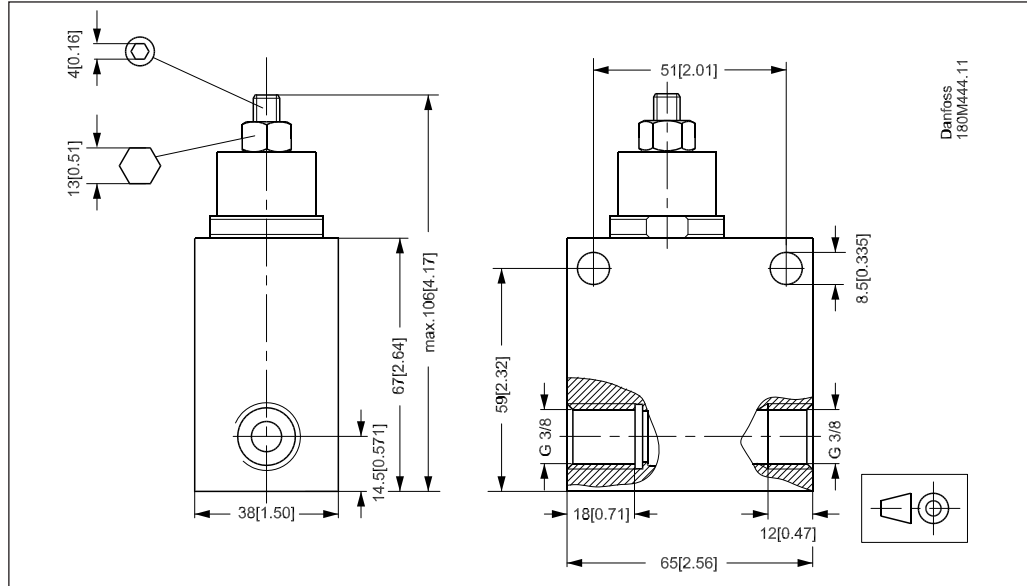

Danfoss
180M444.11

CETOP valves

**Dimensions (mm)
VOCH 30 MC**

Double throttle check valve

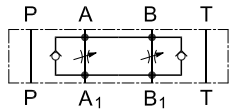

Danfoss
180M523.10

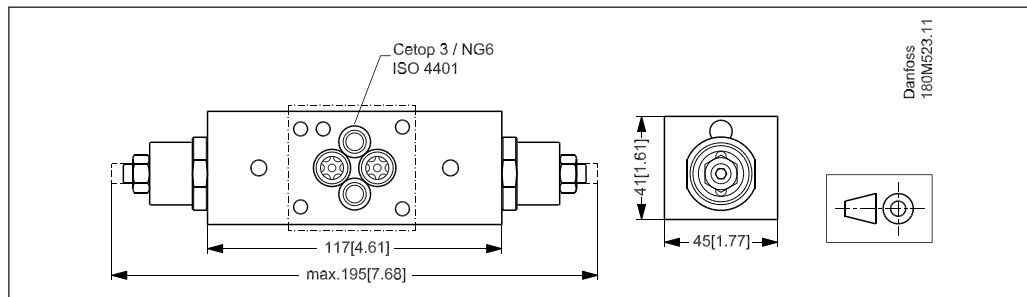

Danfoss
180M523.11

CETOP valves

**Dimensions (mm)
VOH 30 MC**

Single throttle valve

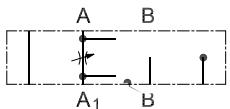

Danfoss
180M572.10

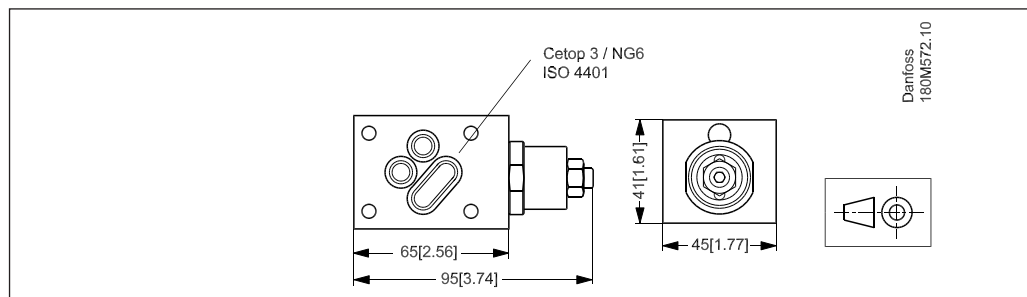

Danfoss
180M572.10